

CONTROL DATA® 1700 Computer System

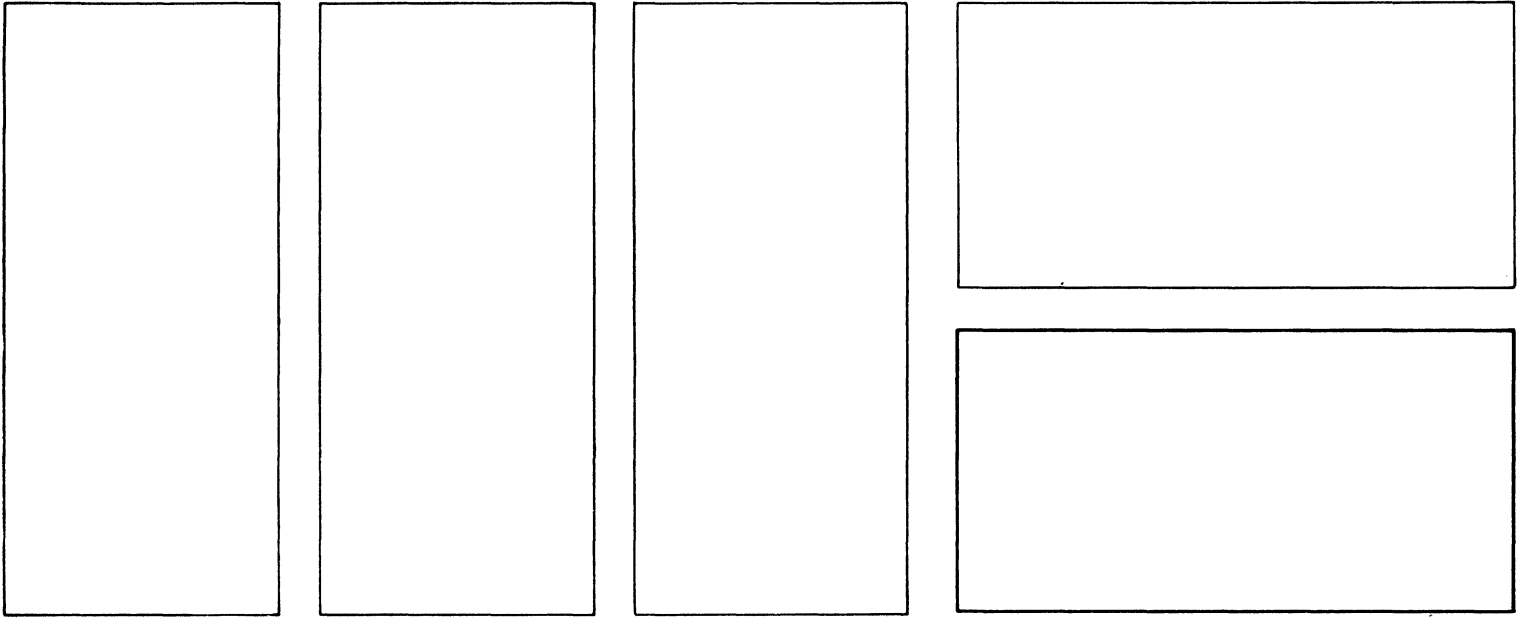

**1728—A/B CARD READER/PUNCH CONTROLLER
REFERENCE MANUAL**

PREFACE

This manual gives reference information for the CONTROL DATA® 1728-A/B Card Reader/Punch Controller which may be used in conjunction with the 1705 Interrupt Data Channel of the 1700 Computer. For reference information on 1700 Basic Peripheral Equipments (which attach directly to the 1704 Basic Computer) see the 1700 Computer System Reference Manual, Pub. No. 60153100.



CONTENTS

Introduction	1	Codes	8
Functional Description	1	Converter	8
System Relationship	1	Equipment	8
Capabilities	2	Command	8
Functional Stations	2	Manual Operation	12
Timing	3	Switches and Indicates	12
Definitions of Conditions and Operations	4	Equipment Select Switches	14
Error Indications	5	Maintenance Switches	15
Programming	5	Operation	16

FIGURES

1 Typical Configurations	2	6 Status Code Format-Level 1	7
2 Functional Stations	3	7 Status Code Format-Level 2	7
3 Equipment Select Stations	6	8 Data Transfer Format	7
4 Q Register Format	7	9 Main Control Panel	13
5 Function Code Format	7	10 Maintenance Switch Panel	15

TABLES

1 Description of Functional Stations	3	2 Summary of Q Register Functions	6
--------------------------------------	---	-----------------------------------	---



1728-A/B CARD READER/PUNCH CONTROLLER

INTRODUCTION

The CONTROL DATA® 1728-A/B Card Reader/Punch Controller operates with a CONTROL DATA® 430 Card Reader/Punch. The controller contains eleven 50-PAKS; six for control and interface, and five for operating the Card Reader/Punch mechanism. The controller interfaces with one 1700 Data Channel, either normal or buffered. Function codes transmitted via the data channel initiate and control the reading and punching of cards, and they enable the generation of interrupts when the specified conditions exist. The Card Reader/Punch mechanism is a non-buffered, column-oriented, punched-card, read-punch device with no code conversion. It contains a hopper, stacker, and power supply.

FUNCTIONAL DESCRIPTION

System Relationship

The controller may interface with the 1706 Data Channel for buffered communication or the 1705 Data Channel for normal (non-buffered) communication. Typical configurations are shown in Figure 1. The interface logic in the controller provides access to the card reader via station one, and to the punch via station two of the selected equipment. Data is transferred to and from the Card Reader/Punch in 16-bit computer words with the lower 12 bits containing the information in one card column (data bit 00 corresponds to card row 9). The Q register in the computer designates the use of the A register bits in the 16-line address cable. Bits of the Q register define the equipment number and whether communication is to be with the reader or punch. With a Read or Write signal, they also define A register bits as function codes, status, or data.

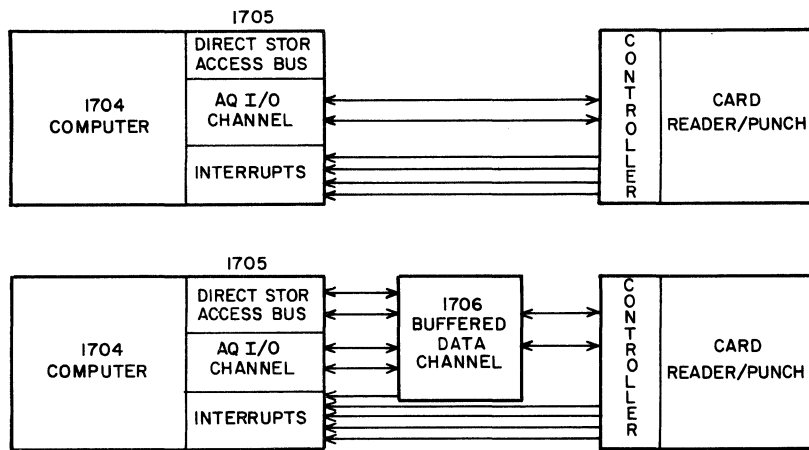

Figure 1. Typical Configurations

Capabilities

The maximum operating rate of the Card Reader/Punch is 500 cards per minute while reading, and 100 cards per minute while punching all card columns. The punching rate is dependent on the number of columns sequenced for punching, with a maximum rate of 476 cards per minute if only the first column is punched. The capacity of the input hopper is 1,200 cards and the capacity of the output stacker is 1,300 cards.

Functional Stations

Refer to Table 1 for a description and to Figure 2 for a diagram of the seven functional stations in the Card Reader/Punch.

TABLE 1. DESCRIPTION OF FUNCTIONAL STATIONS

STATION NUMBER	STATION	DESCRIPTION
1	Hopper	Holds a supply of cards and feeds them to the read ready station.
2	Read Ready	Retains each card as it is fed from the hopper.
3	Read	Examines the cards and presents one column of data on the 12 lines to the logic.
4	Punch Ready	Receives the card as it leaves the read station and indexes it in preparation for punch column one.
5	Punch	Perforates one column of a card for each step as directed by the data lines.
6	Routing	Receives cards as they leave the punch and enables the 3/8 inch offset if directed by the controller.
7	Stacker	Holds the finished card to maintain original card sequence.

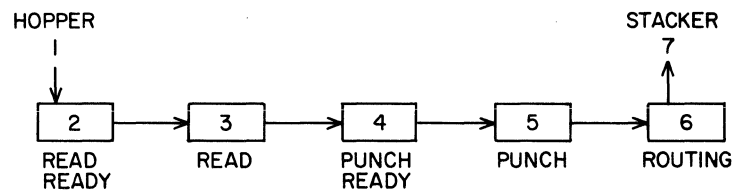

Figure 2. Functional Stations

Timing

Timing intervals for various operations are as follows:

Feed Timing

A card may be fed at intervals of 120 ms for a maximum 500 card-per-minute rate. While operating at this rate, a maximum of 35 ms will be available after reading card column 80 before the controller need issue its decision to feed the next card. A feed cycle may be initiated at any time while punching.

Read Timing

The read time for card columns 1 through 80 is 57.275 ms. The average time for reading a card column is 725 usec. Column one will be present for reading approximately 18 ms after the initiation of a feed cycle from a static position with the motor running, or 60 ms after feed-cycle initiation from a column 80 position.

Punch Timing

The punch time for columns 1 through 80 is 474 ms. A card column may be punched at intervals of 6 ms for a maximum rate or at any slower rate required. A card is ready for punching approximately 120 ms after the feed cycle is initiated.

Offset Timing

A card will be offset in the stacker if an Offset command is issued any time after reading column 40, and before 10 ms have elapsed of the card cycle in which the card is moving to the routing station.

Definitions of Conditions and Operations

Various conditions and operations in the Card Reader/Punch are defined as follows:

Ready

A Ready condition exists when the Card Reader/Punch is capable of performing all its functions. Pressing the READY switch causes the equipment to become ready if the power supply is in operation, cards are in the input hopper, the stacker is not full, there is no jam condition, the chip box is in place and not full, and the top lid interlock is closed.

Reader Busy

The reader becomes busy when a feed cycle is initiated and remains busy until the completion of a card (81st column time), or until lost data occurs.

Punch Busy

The punch becomes busy when a Reply is sent for the first data output and remains busy until a Feed command is issued or the completion of a card (81st column time).

Read Operation

A Read operation is the time between the acceptance of a Feed command to station 1, and the completion of a card (81st column time) or the time lost data occurred.

NOTE

In this equipment, reader and punch operations are not allowed to overlap.

Punch Operation

A Punch operation is the time between the acceptance of the first data word to station 2 and the completion of a card (81st column time).

NOTE

If the Read or Punch operation is terminated before the 81st column time with a Feed command, no end of operation status or interrupt is issued.

Alarm

An alarm indicates the presence of an abnormal condition. Two types of abnormal conditions can occur; those which require the Card Reader/Punch to go Not Ready, and require operation intervention, and those which allow the Ready status to remain, and do not require operator intervention.

Alarm with Not Ready: This Alarm condition is caused by a condition which causes the Card Reader/Punch to become Not Ready. These conditions are the chip box full, chip box not in place, hopper empty, stacker full, feed alert, or open interlock on the top lid. The alarm is cleared upon correction of the cause for the Not Ready condition.

Alarm with Ready: This Alarm condition is caused by lost data or a punch or read error. The alarm may be cleared by a Master Clear or a Clear Card Reader/Punch director function code.

Error Indications

Not Ready

The absence of any one of the following Ready conditions results in a Not Ready error condition.

- a. Power supply in operation.
- b. Cards in the input hopper.
- c. Card stacker not full.
- d. No card jam condition.
- e. Chip box in place and not full.
- f. Top lid interlock closed.

Pre-read Error

This error occurs if all read amplifiers are not on during a light check, or if the amplifiers are not off during a dark check.

Punch Error

This error occurs when a faulty signal is detected in the area of the punch solenoid and echo amplifier circuits during echo checks.

Alarm

The presence of any abnormal condition results in an Alarm error. An alarm can cause the equipment to go Not Ready or it can exist and allow the Ready state to remain. Conditions causing a Not Ready are:

- a. Chip box full or out of place.
- b. Hopper empty.
- c. Stacker full.
- d. FEED ALERT indicator lighted.
- e. Open top lid interlock.

Conditions allowing the Ready state to remain are:

- a. Lost data.
- b. READ ALERT or PUNCH ALERT indicators lighted.

Feed Alert

This error occurs when there has been a failure in the transport of a card. This may be due to a card failing to feed, or a jam occurring in the read, punch, or stacker area.

PROGRAMMING

Table 2 and Figures 3 through 8 provide programming information.

A description of the codes follows the figures.

TABLE 2. SUMMARY OF Q REGISTER FUNCTIONS

Q REGISTER		DESCRIPTION
FORMAT	SYMBOL	
CONVERTER CODE	(W)	W=0 must be present for all Card Reader/Punch operations.
EQUIPMENT CODE	(E)	Set Equipment Select switches - positions 0 thru F (An Equipment Code setting must be present for all operations).
STATION CODE	(S)	Select station (Q05, Q06) For reader, Q05=1 and Q06=0 with Read signal. For punch, Q05=0 and Q06=1 with Write signal.
DIRECTOR CODE	(D)	Defines operation (Q00, Q01) For data, Q00=0 Reader, Q05=1, Q06=0 with Read signal. Punch, Q05=0, Q06=1 with Write signal. For function, Q00=1 with Write signal and Station code. For status, Q00=1, with a Read signal, and the following: for Level 1, Q01=0 for Level 2, Q01=1

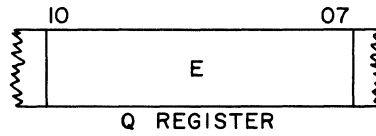

E (EQUIP CODE) = Q07-Q10 = ANY ONE OF SWITCH NUMBERS 0 - F

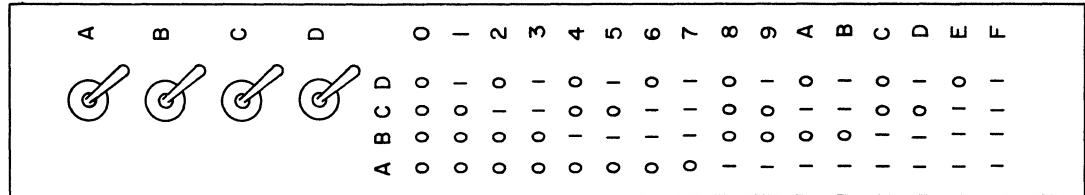

Figure 3. Equipment Select Switches

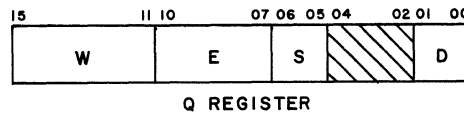

Figure 4. Q Register Format

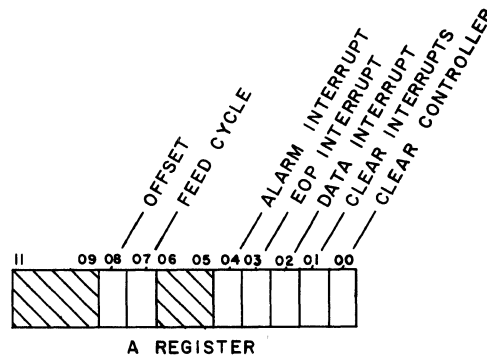

Figure 5. Function Code Format

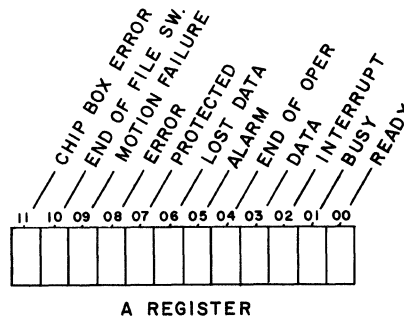

Figure 6. Status Code Format - Level 1

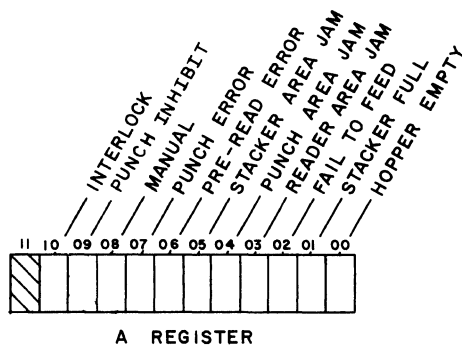

Figure 7. Status Code Format - Level 2

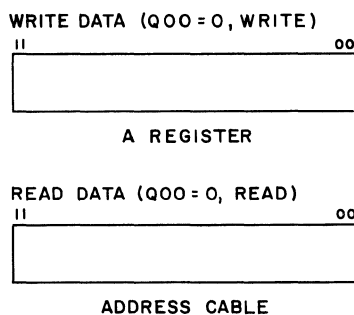

Figure 8. Data Transfer Format

CODES

Converter

The W portion of the Q register (Q11-Q15) must be all "0's" for all Card Reader/Punch operations.

Equipment

The E portion of the Q register (Q07-Q10) defines the Card Reader/Punch equipment code. The code is set up by the switches shown in Figure 3. If the switch settings match bits 07-10 of Q, the equipment responds.

Command

When accompanied by an equipment code and either a Read or Write signal, a command code defines the operation to be performed. The command code consists of a station (S) code and a director (D) code. Only bits 05 and 06 of the S code are used. When Q5=1 and Q6=0, the station being communicated with is the reader. When Q5=0 and Q6=1, the station being communicated with is the punch. The D portion of Q (Q00 and Q01) defines the word being sent as data, or director function or status codes.

NOTE

If both Q5 and Q6=1, or if both Q5 and Q6=0, the Card Reader/Punch will not accept the word being sent, and will not send a Reply or Reject signal.

DATA TRANSFER

Read Data (Q00=0, Q01=0, Q05=1, Q06=0)

When bit Q05 is a "1" and bits Q00, Q01 and Q06 are "0", the 16 lines of the data cable (A) are directed to perform a data transfer as specified by the Read signal. A Reject condition will occur if the data cannot be transferred. The card reader will reject data when:

- a. The Card Reader/Punch is not ready.
- b. The computer attempts to input data at a rate that exceeds the capabilities of the Card Reader/Punch.
- c. The 80th column has been read or a feed command has been accepted and a new card has not been registered in the read station.

Write Data (Q00=0, Q01=0, Q05=0, Q06=1)

When bit Q06 is a "1" and bits Q00, Q01, and Q05 are "0", the 16 lines of the data cable (A) are directed to perform a data transfer as specified by the Write signal. A Reject will occur if data cannot be accepted. The punch will reject data when:

- a. The Card Reader/Punch is Not Ready.
- b. The computer attempts to output data at a rate that exceeds the capabilities of the Card Reader/Punch.
- c. The 80th column has been punched and a new card has not yet been registered in the punch station.

DIRECTOR FUNCTIONS (Q00=1, Q01=0)

When Q00 is "1" and Q01 is "0", and they are accompanied by an equipment and station code, together with a Write signal, the 16 lines of the data cable (A) will direct the Card Reader/Punch to perform the following operations. Director functions may be stacked (two or more functions sent simultaneously).

Clear Card Reader/Punch (A00=1)

This function directs the clearing of all interrupt requests and responses, motion requests, errors, and other logic which may be cleared. This bit is subordinate to bits A02 through A08.

NOTE

The Card Reader/Punch will execute and reply to this function if it is Not Ready, provided that no other director bit, except A01, is transmitted with it (bits A02 through A08 must be zero). Care should be exercised in using this function while the Card Reader/Punch is busy.

Clear Interrupts (A01=1)

This function directs that all Interrupt Requests and their responses be cleared. It is subordinate to the interrupt request bits A02 through A04.

NOTE

The Card Reader/Punch will execute and reply to this function if it is Not Ready, provided that no other director bit, except A00, is transmitted with it (bits A02 through A08 must be zero).

Data Interrupt Request (A02=1)

This function causes the data Interrupt Request FF to be set. This causes an interrupt to be generated when an information transfer may occur. The interrupt will be cleared by a reply to a data transfer. Interrupt request and response is cleared by bit A00 or A01. Interrupt request takes precedence over function clears. Each station (punch or reader) has a data interrupt request.

Interrupt on End of Operation (A03=1)

The purpose of this interrupt is to notify the computer that the unit is finished with an operation or that some condition existed at the end of the last data transfer which will prevent any further data transfers. Interrupt request and response is cleared by bit A00 or A01. Interrupt request takes precedence over function clears. Each station has an End of Operation interrupt request.

The interrupt may be selected before or during the operation. An interrupt response will not occur for an operation which was ended before the selection was made.

Alarm Interrupt Request (A04=1)

This function enables the generation of an interrupt when an Alarm condition exists. These conditions are listed in the Alarm section. An Alarm condition that exists at the time of the interrupt request will immediately provide a response. If the Alarm condition does not exist at the time of the interrupt request, the interrupt response will be provided as soon as the Alarm condition is detected.

The Alarm Interrupt Request may be cleared by a Master Clear or by either A00=1 or A01=1 with A04=0.

The interrupt response may be cleared by a Master Clear or by either A00=1 or A01=1. When the interrupt response is cleared by Director Function A00=1 or A01=1, the interrupt request may be reset with the same operation if A04=1.

Director functions A05 and A06 are not used.

Feed Request (A07=1)

This function directs the Card Reader/Punch to initiate a feed cycle and to advance the next card.

- a. Feed and Read - When a Feed Request is initiated with Q05=1 and Q06=0 (Read Station Code), the pre-read checks are made on the light detection circuits. Lost data error will be detected, if present.

- b. Feed and Punch - When a Feed Request is initiated with Q05=0 and Q06=1 (Punch Station Code), the pre-read and lost data checks are not made. The logic regards this as a Feed Request for punching only. Reading may not be done.

Offset Request (A08=1)

This function directs the Card Reader/Punch to initiate an offset operation. This operation shall cause the existing card to be offset approximately 3/8 inch (column 80 end protruding) from the stacker card deck.

Director functions A09 through A15 are not used.

DIRECTOR STATUS (Q00=1, Q01=0), LEVEL 1

When Q00 is a 1 and Q01 is a 0, and a Read signal is present, Level 1 status information is gated to the computer.

Ready (A00=1)

This bit indicates that a Ready condition exists. The requirements are as follows:

- a. Power supply in operation.
- b. Cards present in input hopper.
- c. Stacker not full.
- d. No jam condition present.
- e. Chip box in place and not full.
- f. Top lid interlock closed.

A Ready ceases to exist when any of the above conditions are not met or when the Card Reader/Punch READY switch is pressed when the Card Reader/Punch is in the Ready Condition.

Busy (A01=1)

This bit indicates that the Card Reader/Punch is busy. The card reader becomes busy when a feed cycle is initiated and remains busy until an End of Operation occurs. The punch becomes busy when a Reply is sent for the first data output and remains busy until a Feed command is issued or an End of Operation occurs.

Interrupt (A02=1)

This bit indicates that an interrupt response was generated by the Card Reader/Punch. The other status bits must be monitored to determine the cause of the interrupt.

Data (A03=1)

This bit indicates that a data transfer may occur.

- a. Reader Data - The Reader register contains information ready for transfer to the computer. The status and interrupt will drop upon completion of the transfer.
- b. Punch Data - The Punch register is empty and an unpunched column is under the punch head. The status and interrupt will drop upon transfer of data to the Punch register.

End of Operation (A04=1)

This bit indicates that the Card Reader/Punch has completed an operation. This can be either a Read or Punch operation which are described in the Definitions of Conditions and Operations section.

Bit A05 is not used.

Lost Data (A06=1)

This bit indicates that data was not transferred out of the Read register before the next column of a card being read appeared. The status drops when a clear(A00=1) is sent to the controller.

NOTE

When lost data occurs, no further transfers will occur from that card, and an End of Operation status will be generated.

Protected (A07=1)

This bit indicates that the Protect switch on the Card Reader/Punch is in the PROTECT position. When the switch is in the PROTECT position, the Card Reader/Punch will accept only those instructions having a "1" on the program protect line. All other instructions will be rejected. A protected instruction can be used with either a protected or unprotected Card Reader/Punch.

Error (A08=1)

This bit indicates that either a pre-read or punch error has occurred. Level 2 status may be check to determine which of these two errors, or both, have caused the error status.

Feed Alert (A09=1)

This bit indicates that sometime during a card cycle there was a failure in the transport of the card. This can be caused by:

- a. Failure to feed the card.
- b. Read area jam.
- c. Punch area jam.
- d. Stacker area jam.

End of File (A10=1)

This bit indicates that the End of File switch is on and that the End of File condition is present. This allows reading or punching the remaining cards still in the transport after the hopper goes empty.

Chip Box (A11=1)

This bit indicates that the chip box is full or not in position. Emptying the chip box and replacing it will cause the status to drop.

Bits A12 through A15 are not used.

DIRECTOR STATUS (Q00=1, Q01=1 or 0), LEVEL 2

When Q00 and Q01 are 1's, and a Read signal is present, Level 2 status information is gated to the computer.

Hopper Empty (A00=1)

This bit indicates that this status is up while the input feed hopper is out of cards.

Stacker Full (A01=1)

This bit indicates this status is present while the output stacker is filled to capacity.

Fail to Feed (A02=1)

This bit indicates that this status will be present if the Read Ready area fails to contain a card after a feed cycle has occurred, and if the input hopper contains cards.

Read Area Jam (A03=1)

This bit indicates that a card transport failure has occurred in the Read area.

Punch Area Jam (A04=1)

This bit indicates that a card transport failure has occurred in the Punch area.

Stacker Area Jam (A05=1)

This bit indicates that a card transport failure has occurred in the Stacker area.

Pre-read Error (A06=1)

This bit indicates that an amplifier failure in the read head was detected.

Punch Error (A07=1)

This bit indicates that the results of the punch echo check do not agree with the requested punch information.

Manual (A08=1)

This bit indicates that the maintenance panel FEED switch is on, placing the Card Reader/Punch under manual control.

Punch Inhibit (A09=1)

This bit indicates that the PUNCH INHIBIT switch on the control panel is on.

Interlock (A10=1)

This bit indicates that the door interlock switch is de-energized. This occurs when the cabinet doors are open.

Bits A11 through A15 are not used.

MANUAL OPERATION

Switches and Indicators

The switches and indicators shown in Figure 9 are located on the main control panel next to the output stacker. They are described as follows:

POWER Switch and Indicator

Pressing this alternate action switch causes power to be applied to, or removed from, all motors, fans, and power supplies in the proper sequence. The indicator lights to indicate that power is applied to the Card Reader/Punch.

READY Switch and Indicator

Pressing this momentary contact switch causes a card to be fed from the hopper to the Read Ready station if this station is not already holding a card, and if all Not Ready conditions have been resolved satisfactorily. Operation of the switch will also clear the following indications: fail to feed, read alert, and punch alert.

The READY indicator lights if the Card Reader/Punch is ready. When the READY indicator is lighted, pressing and releasing this switch will make the Card Reader/Punch Not Ready and stop any further operations from the computer after the operation in progress is completed.

SINGLE CYCLE Switch

Pressing this momentary contact switch causes a card cycle to occur only if the Card Reader/Punch is in a Not Ready condition. A card cycle occurs regardless of which condition is causing the Not Ready.

NOTE

If the FEED ALERT indicator is lighted, make certain that the card path is clear of possible jam conditions before pressing the SINGLE CYCLE switch.

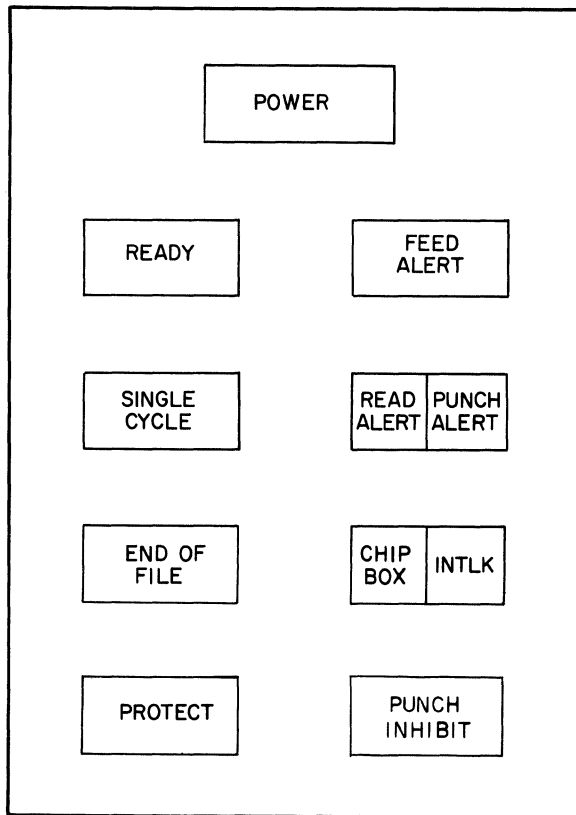

Figure 9. Main Control Panel

END OF FILE Switch and Indicator

Pressing this switch will establish the End of File condition, light the indicator, and generate an End of File status. Pressing the switch again will remove the End of File condition and turn the indicator light off.

The End of File condition allows the Card Reader/Punch to remain Ready after the hopper is empty and there are cards remaining in the transport. This allows reading or punching of the last card in the deck.

PROTECT Switch and Indicator

This alternate action switch, when pressed, places the Card Reader/Punch in the Protected condition, or it can be used to remove the Protected condition. The indicator will be lighted when the Card Reader/Punch is protected. When the switch is on, only protected instructions will be accepted from the computer.

FEED ALERT Indicator

Lights to indicate that sometime during the card cycle there was a failure in the transport of a card. This may be due to:

- a. Failure to feed the card.
- b. Read area jam.

- c. Punch area jam.
- d. Stacker area jam.

This indicator can be cleared by pressing the SINGLE CYCLE OR READY switch.

READ ALERT/PUNCH ALERT Indicator

If a Read Alert occurs, the READ ALERT portion of this divided lens indicator lights. If a Punch Alert occurs, the PUNCH ALERT portion lights. Read and Punch Alerts are defined as follows:

- a. Read Alert - The read control logic performs a check on the operational capabilities of the read circuits prior to reading each card. This consists of detecting that all amplifiers are on when the light detection circuits are all uncovered (light check) and of detecting that the amplifiers are all off when the light detection circuits are all covered (dark check). Any error found by these checks will be a pre-read error and it will light the READ ALERT indicator.
- b. Punch Alert - Each punch solenoid has an associated echo amplifier which receives an input from the solenoid each time its respective punch has been active. A check of these signals (echo) is made to determine if the data punched was the same as the data required to be punched. Any error found by this check will be a Punch error and it will light the PUNCH ALERT indicator.

CHIP BOX/INTLK Indicator

If a chip box warning (chip box full, or out of place) occurs, the CHIP BOX portion of this divided lens indicator will light. If the top lid interlock is open, the INTLK portion will light.

PUNCH INHIBIT Switch and Indicator

This alternate action switch inhibits all program-controlled (computer-directed) punching. The indicator will be lighted for the Inhibit condition. This switch does not affect the operation of the switches on the maintenance panel.

Equipment Select Switches

Refer to the Programming section for a description of these switches.

Maintenance Switches

The maintenance switch panel, Figure 10, contains ten switches which allow the Card Reader/Punch to be adjusted and checked off-line. This switch panel is located on the lower right side of the logic chassis.

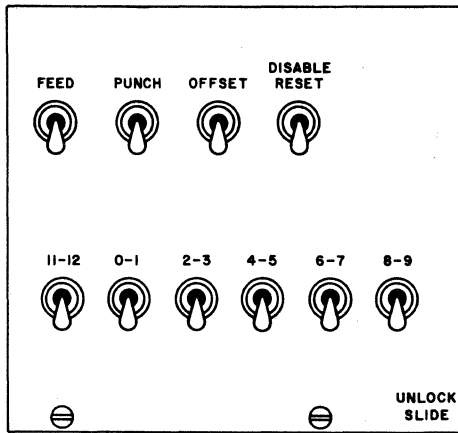

Figure 10. Maintenance Switch Panel

Bit Switches

There are six bit switches on the maintenance panel. Each switch controls the punching of two rows on a card.

FEED Switch

This switch feeds cards at maximum card rate, allowing checks to be made on the reader control logic.

NOTE

The Card Reader/Punch must be ready for the FEED switch to operate. Therefore, sequence switches as follows. Set the FEED switch to separate the Card Reader/Punch from the computer. Use the READY switch on the main control panel to start and stop feeding of cards.

PUNCH Switch

This toggle switch allows the punching of solid rows of holes on a card. The particular pairs of rows to be punched can be controlled by the bit switches.

NOTE

The FEED switch must be on for the PUNCH switch to operate.

OFFSET Switch

This switch allows checking the operation of the offset stacker feature.

NOTE

Since the OFFSET switch is not controlled by the FEED switch, it must be turned off when the Card Reader/Punch is on-line.

DISABLE RESET Switch

This switch disables the automatic reset feature in the card reader control logic.

NOTE

The FEED switch must be on for this switch to operate.

Operation

Prepare the Card Reader/Punch for operation as follows:

- a. Turn on power by pressing the POWER switch, Figure 9.
- b. Load a deck of cards, face down, with the 9 edge toward the inside of the hopper.
- c. Press the READY switch to single-cycle a card into the Read Ready area.

OPERATOR MAINTENANCE

Cleaning

Every 20 operating hours the card path should be cleaned in accordance with the following procedure.

1. Open top rear door.
2. Raise the read ready station access door.
3. Raise the read head and the punch ready station access door.
4. Raise the routing station access door.
5. Using a paint brush or other similar soft brush, start at the input hopper and remove all card dust and other foreign matter from the card path, including the output stacker. Ensure that photocells and the read head are completely free of dust.
6. Remove punch head removable bed assembly. Clean the bed assembly.
7. Using soft brush, remove all card dust from under side of punch head.
8. Raise the punch head pinch rollers by turning actuator shaft handle. While pinch rollers are raised, insert a card into punch head and remove card dust and foreign matter from punch head.
9. Using a vacuum cleaner, clean all card path areas.
10. Vacuum-clean pan under card transport.
11. Using a clean rag, wipe out remaining dust from the card path. Wipe off stacker rails.

- Using a toothpick or other soft non-metal pick, clean out any foreign matter from the step on the picker knife.

Card Jam Removal

Whenever a card jam occurs, as indicated by the lighting of the FEED ALERT indicator, perform the following jam removal procedure.

CAUTION

When a card jam occurs, do not attempt to single cycle the machine. Damage to the card transport or punch head may result.

- Open top rear door.
- Inspect card read punch transport assembly and stacker routing station for a card jam.
- If there are torn or mutilated cards or if there are multiple cards along the card path or in a station, remove the cards after raising the applicable access doors.
- If no cards are in the read ready station, remove card hold down lid and card deck from input hopper.

CAUTION

In the following step(s), be sure the motor power circuit breaker is turned OFF (down position) before turning the punch head hand wheel.

- If a card is jammed in the hopper feeder, pull the card back through the input hopper. If the card tears apart, rotate the punch head hand wheel and remove any remaining card pieces out through the read ready station.
- If a jam occurs in the punch head, rotate hand wheel two or three times to ensure punches are latched up. In order for the punches to latch up the power must be on.
- Remove removable bed assembly.
- Raise punch head pinch rollers by turning actuator shaft handle.
- While pinch rollers are raised, remove the card on the input side of the punch head first by pulling it back. Attempt to push the card on the output side of the punch back through the input side. If unable to do so, pull the card out the output side, using special care not to tear the card. If the card tears, ensure all parts are removed from punch head by sliding a card through punch head and working out any remaining parts.

CAUTION

Do not perform the following procedure unless all other attempts to clear torn parts from the punch head have failed. Improper or careless use of the tool may cause permanent damage to the punch head.

- Very carefully slide card jam tool, part number 82659500, in punch head and work torn parts free. Ensure that the tool does not hit either of the two stepper drive wheels.

COMMENT SHEET

MANUAL TITLE 1728-A/B CARD READER/PUNCH CONTROLLER

Reference Manual

PUBLICATION NO. 60331000 REVISION A

FROM: NAME: _____
BUSINESS
ADDRESS: _____

COMMENTS:

This form is not intended to be used as an order blank. Your evaluation of this manual will be welcomed by Control Data Corporation. Any errors, suggested additions or deletions, or general comments may be made below. Please include page number references and fill in publication revision level as shown by the last entry on the Record of Revision page at the front of the manual. Customer engineers are urged to use the TAR.

CUT ALONG LINE

PRINTED IN U.S.A.

AA3419 REV. 11/69

NO POSTAGE STAMP NECESSARY IF MAILED IN U. S. A.

FOLD ON DOTTED LINES AND STAPLE

STAPLE

STAPLE

FOLD

FOLD

FIRST CLASS
PERMIT NO. 8241
MINNEAPOLIS, MINN.

BUSINESS REPLY MAIL
NO POSTAGE STAMP NECESSARY IF MAILED IN U.S.A.

POSTAGE WILL BE PAID BY
CONTROL DATA CORPORATION
4201 North Lexington Avenue
Arden Hills, Minnesota 55112

ATTN: TECHNICAL PUBLICATIONS DEPT.
PLANT TWO



CUT ALONG LINE

FOLD

FOLD